

AUTOMOTIVE CURRENT TRANSDUCER

HAH1BV S/13



Introduction

The HAH1BV family is for the electronic measurement of DC, AC or pulsed currents in high power automotive applications with galvanic isolation between the primary circuit (high power) and the secondary circuit (electronic circuit).

The HAH1BV family gives you the choice of having different current measuring ranges in the same housing (from ± 200 A up to ± 700 A).

Features

- Open Loop transducer using the Hall effect
- Unipolar + 5 V DC power supply
- Primary current measuring range up to ± 200 A
- Maximum rms primary current limited by the busbar, the magnetic core or the ASIC temperature $T^\circ < + 150^\circ\text{C}$
- Operating temperature range: $- 40^\circ\text{C} < T^\circ < + 125^\circ\text{C}$
- Output voltage: full ratiometric (in sensitivity and offset)
- Compact design.

Advantages

- Excellent accuracy
- Very good linearity
- Very low thermal offset drift
- Very low thermal gain drift
- Wide frequency bandwidth
- No insertion losses.

Automotive applications

- Battery monitoring
- Starter Generators
- Inverters
- HEV application
- EV application.

Principle of HAH1BV Family

The open loop transducers use an Hall effect integrated circuit.

The magnetic flux density B , contributing to the rise of the Hall voltage, is generated by the primary current I_p to be measured.

The current to be measured I_p is supplied by a current source i.e. battery or generator (Fig. 1).

Within the linear region of the hysteresis cycle, B is proportional to:

$$B (I_p) = \text{constant} (a) \times I_p$$

The Hall voltage is thus expressed by:

$$V_H = (R_H/d) \times I \times \text{constant} (a) \times I_p$$

Except for I_p , all terms of this equation are constant. Therefore:

$$V_H = \text{constant} (b) \times I_p$$

The measurement signal V_H amplified to supply the user output voltage or current.

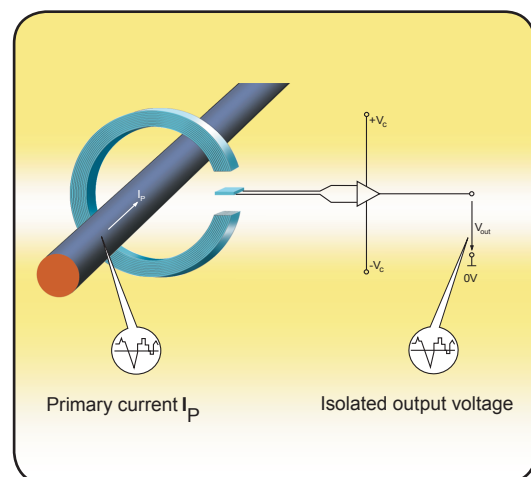
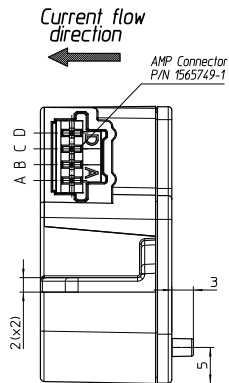

Fig. 1: Principle of the open loop transducer

HAH1BV S/13

Dimensions HAH1BV family (in mm. 1mm = 0.0394 inch)

Right view



MOUNTING RECOMMENDATION

- Use screws $\phi 4$ mm
- Tightening torque : 1.5 Nm $\pm 5\%$ (1.1 lbf.ft)
- Use plain washers and "Grower" spring washers

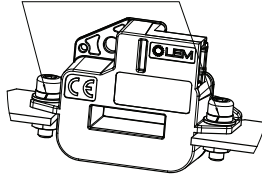

Bottom view

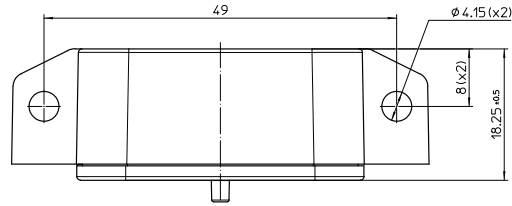

Front view

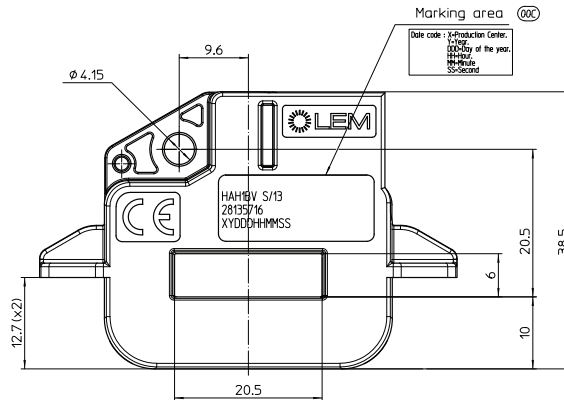

Top view

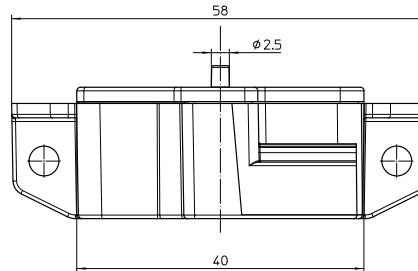

System architecture (example)

Bill of materials

- Plastic case PBT GF 30
- Magnetic core Iron silicon alloy
- Pins Brass tin plated
- Weight 39 g

Remarks

- $V_{OUT} > \frac{V_c}{2}$ when I_p flows in the direction of the arrow.

$R_L > 10$ k Ω optional resistor for signal line diagnostic

V_{OUT}	Diagnosis
Open circuit	$V_{IN} = V_c$
Short GND	$V_{IN} = 0V$

$C_L < 100$ nF EMC protection

RC Low pass filter EMC protection (optional)

System architecture

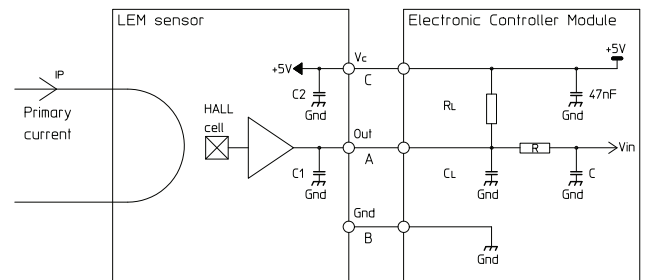
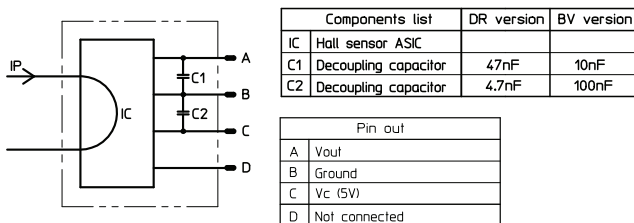

HAH1BV S/13

Absolute maximum ratings

	Symbol	Unit	Specification			Conditions
			Min	Typ	Max	
Electrical Data						
Maximum primary current peak	I_{Pmax}	A			¹⁾	
Supply continuous over voltage	V_C	V			8.5	
Supply over voltage					14	1 min
Reverse voltage			-14			1 min @ $T_A = 25^\circ\text{C}$
Output over voltage (continuous)	V_{OUT}	V			8.5	
Output over voltage					14	1 min @ $T_A = 25^\circ\text{C}$
Continuous output current	I_{OUT}	mA	-10		10	
Output short-circuit duration	T_C	min			2	
Rms voltage for AC isolation test	V_d	kV			2	50 Hz, 1 min
Isolation resistance	R_{IS}	MΩ	500			500 V - ISO 16750-2
Electrostatic discharge voltage	V_{ESD}	kV			2	JESD22-A114-B
Ambient storage temperature	T_S	°C	-40		125	

Operating characteristics

	Symbol	Unit	Specification			Conditions
			Min	Typ	Max	
Electrical Data						
Primary current	I_P	A	-200		200	
Calibration current	I_{CAL}	A	-200		200	@ $T_A = 25^\circ\text{C}$
Supply voltage	V_C	V	4.5	5.00	5.5	
Output voltage	V_{OUT}	V	$V_{OUT} = (V_C/5) \times (2.5 + G \times I_P)$			@ V_C
Sensitivity ²⁾	G	mV/A		10		@ $V_C = 5\text{ V}$
Current consumption	I_C	mA		7	10	@ $V_C = 5\text{ V}$, -40°C < T_A < 125°C
Power up inrush current		mA			15	@ $V_C < 3.5\text{ V}$
Load resistance	R_L	KΩ	10			
Output internal resistance	R_{OUT}	Ω			10	
Capacitive loading	C_L	nF	1		100	
Ambient operating temperature	T_A	°C	-40		125	
Output drift versus power supply		%	-1	0.3	1	
Performance Data						
Sensitivity error	ε_G	%	-1.0	± 0.5	1.0	@ $T_A = 25^\circ\text{C}$, '@ $V_C = 5\text{ V}$
Electrical offset current	I_{OE}	A		± 0.5		@ $T_A = 25^\circ\text{C}$, '@ $V_C = 5\text{ V}$
Magnetic offset current	I_{OM}	A		± 0.6		@ $T_A = 25^\circ\text{C}$, '@ $V_C = 5\text{ V}$ after ± I_P
Globe offset current	I_O	A		± 1.1		@ $T_A = 25^\circ\text{C}$
			-2.2		2.2	
Average temperature coefficient of V_{OE}	$TCV_{OE AV}$	mV/°C	-0.06	± 0.02	0.06	@ -40°C < T_A < 125°C
Average temperature coefficient of G	TCG_{AV}	%/°C	-0.04	± 0.02	0.04	@ -40°C < T_A < 125°C
Linearity error	ε_L	%	-1.0		1.0	of full range
Response time to 90 % of I_{PN} step	t_t	ms			5	@ di/dt = 50 A/μs
Frequency bandwidth	BW	kHz	1.75	2		@ -3 dB
Output clamping min voltage	V_{sz}	V	0.24	0.25	0.26	@ $V_C = 5\text{ V}$
Output clamping max voltage	V_{sz}	V	4.74	4.75	4.76	@ $V_C = 5\text{ V}$
Output voltage noise peak peak	$V_{no,pp}$	mV	-		10	
Resolution		mV		2.5		@ $V_C = 5\text{ V}$
Power up time		ms		25	100	
Setting time after overload		ms			25	

Notes: ¹⁾ Busbar temperature must be below 150°C.

²⁾ The output voltage V_{OUT} is fully ratiometric. The offset and sensitivity are dependent on the supply voltage V_C relative to the following formula:

$$I_P = \left(V_{OUT} - \frac{V_C}{2} \right) \times \frac{1}{G} \times \frac{5}{V_C} \quad \text{with } G \text{ in } (V/A)$$

HAH1BV S/13

HAH1BV S/07 Gain Error (%)

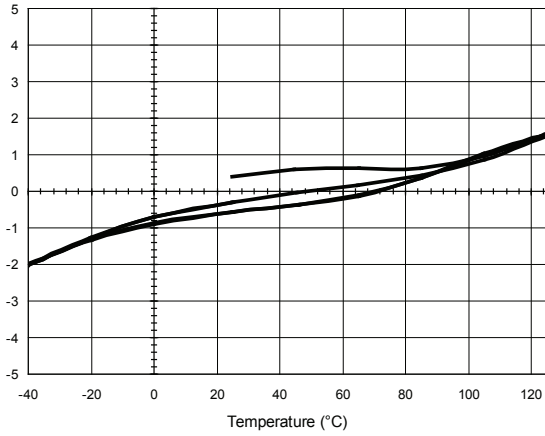

HAH1BV S/07 Electrical offset Error (A)

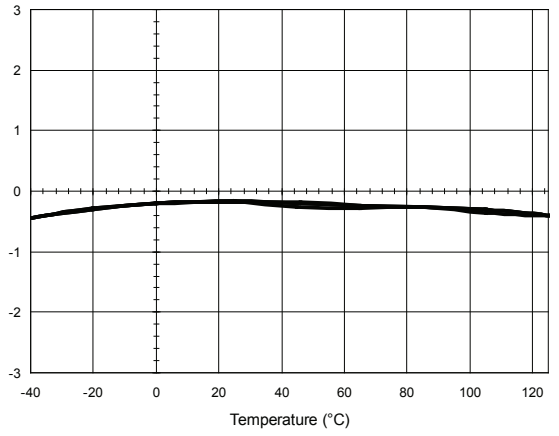

HAH1BV S13 - Frequency BandWidth

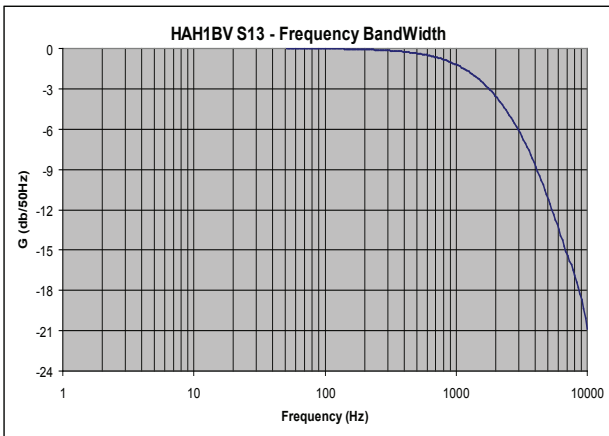

HAH1BV S/07 Phase

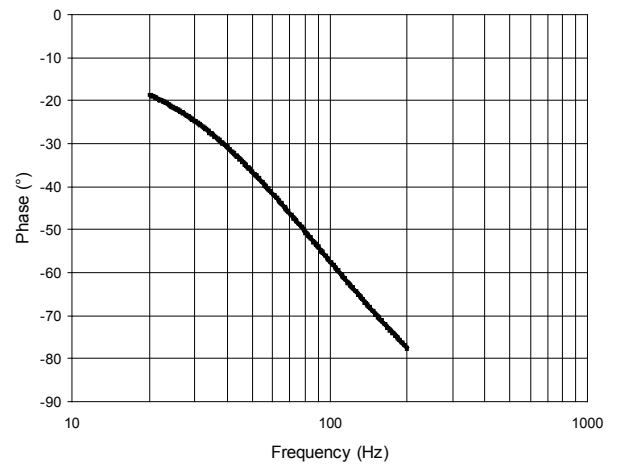

HAH1BV S/13

PERFORMANCES PARAMETERS DEFINITIONS

Output noise voltage:

The output voltage noise is the result of the noise floor of the Hall elements and the linear I_c amplifier gain.

Magnetic offset:

The magnetic offset is the consequence of an over-current on the primary side. It's defined after an excursion of $I_{p\max}$.

Linearity:

The maximum positive or negative discrepancy with a reference straight line $V_{OUT} = f(I_p)$.

Unit: linearity (%) expressed with full scale of $I_{p\max}$.

Linearity is measured on cycle + I_p , 0, - I_p , 0, + I_p without magnetic offset (average values used)

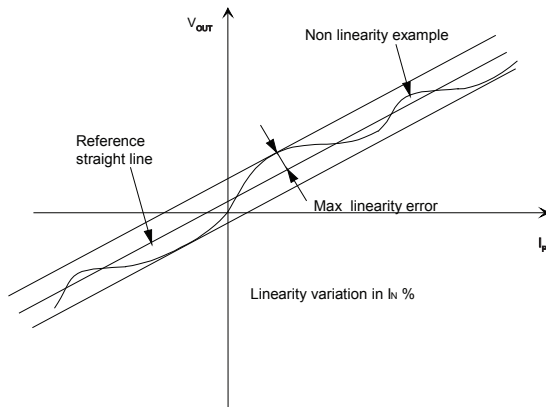

Response time (delay time) t_r :

The time between the primary current signal and the output signal reach at 90 % of its final value

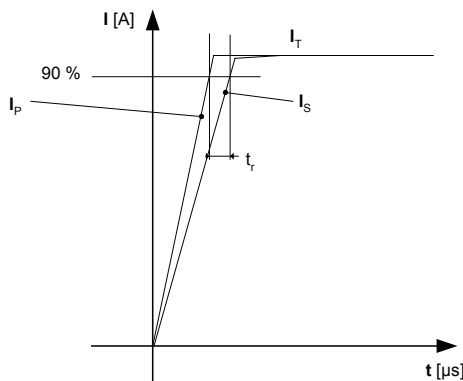

Typical:

Theoretical value or usual accuracy recorded during the production.

Sensitivity:

The Transducer's sensitivity G is the slope of the straight line

$V_{out} = f(I_p)$, it must establish the relation:

$$V_{out}(I_p) = V_c/5 (G \times I_p + 2.5) (*)$$

(*) For all symetrics transducers.

Offset with temperature:

The error of the offset in the operating temperature is the variation of the offset in the temperature considered with the initial offset at 25°C.

The offset variation I_{OT} is a maximum variation the offset in the temperature range:

$$I_{OT} = I_{OE\max} - I_{OE\min}$$

The Offset drift TCI_{OEAV} is the I_{OT} value divided by the temperature range.

Sensitivity with temperature:

The error of the sensitivity in the operating temperature is the relative variation of sensitivity with the temperature considered with the initial offset at 25°C.

The sensitivity variation G_T is the maximum variation (in ppm or %) of the sensitivity in the temperature range:

$$G_T = (Sensitivity\ max - Sensitivity\ min) / Sensitivity\ at\ 25^\circ C.$$

The sensitivity drift TCG_{AV} is the G_T value divided by the temperature range.

Offset voltage @ $I_p = 0$ A:

Is the output voltage when the primary current is null. The ideal value of V_o is $V_c/2$ at $V_c = 5$ V. So, the difference of $V_o - V_c/2$ is called the total offset voltage error. This offset error can be attributed to the electrical offset (due to the resolution of the ASIC quiescent voltage trimming), the magnetic offset, the thermal drift and the thermal hysteresis.

Environmental test specifications

Name	Standard	Conditions
Damp heat, steady state	JESD22-A101	85°C - 85°C / 1000h
Isolation resistance	ISO 16750-2 § 4.10	500 V/1min
Temperature humidity cycle test	ISO 16750-4	-10 + 85°C 10 days
Isolation test	IEC 60664-1	2 kV/50 Hz/1min
Mechanical tests		
Vibration test in temperature	550 1675-3	- 40°/125°C 10 - 1000 Hz 2.78 g/8H 3 axis
Terminal strength test	According to LEM	
Thermal shocks	IEC 60068-214 Na	-40 + 125°C 300 cycles
Free fall	ISO 16750-3 § 4.3	1m concrete ground
EMC Test		
Radiated electromagnetic immunity	Directive 2004/104/CE ISO 11452-2	30 V/m 20-2000 MHz
Bulk current injection immunity	Directive 2004/104/CE ISO 11452-4	1-400 MHz
Radiated radio frequency electromagnetic field immunity	IEC 61000-4-3	80000 MHz-10V/m
Electrostatic discharge immunity test	IEC 61000-4-2	Air discharge=2 kV